

LCL-filter Optimization Design Considering Stability of Grid-Connected Inverters in Microgrid

Tiantian Chen
Electric Power Research
Institute of State Grid
Shanghai Electric Power
Company – China

Peng Zhang
Electric Power Research
Institute of State Grid
Shanghai Electric Power
Company – China

Ling Luo
Electric Power Research
Institute of State Grid
Shanghai Electric Power
Company – China

Ling Pan
Electric Power Research
Institute of State Grid
Shanghai Electric Power
Company – China

ABSTRACT

As the existing optimized filter of grid-connected inverter design schemes give no consideration to the effect of grid impedances and current controllers, it will eventually cause the grid-connected LCL-filtered inverters lose stability when operating under the microgrid with small short-circuit ratio. This article thus presents a LCL-filter optimization design taking into account stability of grid-connected inverters. In the proposed approach, a multiple-objective optimal model is established, the objective functions of which are minimal damping power loss, minimal cost and optimum current tracking performance, and the constraint about stability is obtained by the impedance analysis method. PSO algorithm with compression factor is used to solve the optimization problem for its unique advantage on the convergence.

Compared with conventional design methods, such as optimized design of LCL filter for minimal damping power loss, the optimization in this article has a higher standardized satisfaction value, which means it can balance well cost and filtering performance and stability margin, especially suited for LCL filter parameters design under microgrid with small short-circuit ratio. For improving practical value of the proposed method, it is further demonstrated that the damp resistance has the most remarkable affect to the optimization results, so the precise selection of damp resistance is indispensable for achieving the desired performances. Moreover, the proposed method has a strong robustness for variation of the main circuit parameters, which makes the optimization design has a better practical value.

Finally, the comparative simulation results verify the effectiveness of the proposed method.

INTRODUCTION

In order to cope with the problem of climate deterioration and depletion of resources, the distributed power generation based on renewable energy such as wind energy and solar energy has been increasingly used in power system. As a connection unit of new energy power generation system and power grid, grid-connected inverter plays an important role in converting direct current into high-quality alternating current energy and feeding it into power grid, and it is widely used in network equipment because of its good performance in

high-frequency harmonic suppression[1]-[2].

Combined with the actual experience, literature [3] introduced the general design method of LCL filter parameters in detail. But it just get the standard design parameters based on experience, and does not involve parameter optimization. Literature [4]-[5] proposed to design the filter parameters with the least damping loss or the smallest component energy storage.

The above optimization methods of LCL filter are all independently calculated under the ideal power grid. When operating under the microgrid, it is easy to cause the designed inverter to lose stability because of the excessive grid impedance [6]. In recent years, many documents take resonance suppression as an important consideration of filter parameter design. Literature [7] introduced the main resonance suppression methods and compared their performances, and the passive damping method has been widely used due to its good robustness and reliability. Literature[8] established a model about total harmonic distortion, and the generalized simple gradient method was used to achieve the minimum on the inductor with ensuring filtering performance, but the influence of grid impedance on system stability was not considered. A design method integrated with LCL filter and current controller optimizations is presented in [9] where the constraints of control performances to LCL parameters are considered.

Most LCL-filter designs do not take into account the effects of stability of inverters, which may cause inverters lose stability when operating under microgrid. A LCL-filter optimization design considering stability of inverters is proposed. First, the mathematical model of LCL grid-connected inverter is established, and the influence of grid impedance on inverter is studied by impedance analysis method. Furthermore, combining with the the constraints of LCL parameter design for inverter stability under microgrid and the requirements of other external characteristics of filter, a multi-objective optimization model with minimal damping power loss, minimal cost and optimum current tracking performance is obtained. Particle swarm optimization with compression factor is used to solve the problem. Finally, a comparative design example is given and the effectiveness of the proposed method is verified by the simulation results.

INFLUENCE OF GRID IMPEDANCE ON GRID-CONNECTED INVERTER UNDER

MICROGRID

Modeling of LCL Grid-Connected Inverter Output Impedance

Fig 1 shows the configuration of a LCL single grid-connected inverter, incorporated into the microgrid.

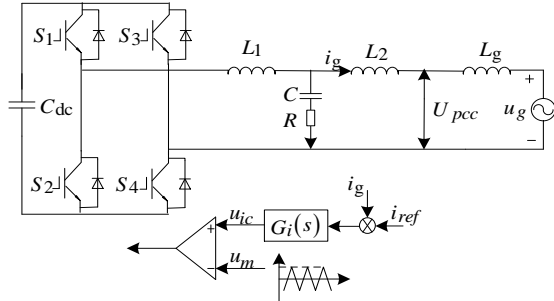

Fig.1 Grid-connected structure of single-phase inverter

Switches S_1 and S_2 , S_3 and S_4 form the two bridge arms of the inverter bridge. The inverter-side filter inductor L_1 , the filter capacitor C and grid-side filter inductor L_2 form the LCL filter of the grid-connected inverter. The damping resistor R is in series with capacitor to suppress the resonance peak. C_{dc} is the DC side energy storage capacitor. Then, i_g is the output current, and u_{pcc} is the PCC voltage. The microgrid is equivalent to the series of voltage source u_g and grid inductor L_g . As for internal control structure of the inverter, i_{ref} is the reference current, and u_{ic} is the output sinusoidal modulation wave, and u_m is the triangular carrier.

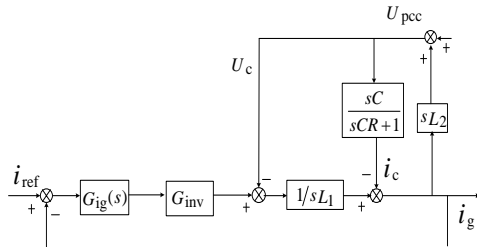

Fig.2 control block diagram of grid-connected inverter

The simplified control block diagram is shown in Fig. 2. The transfer function of using PI-controlled current regulator is expressed as

$$G_{ig}(s) = K_p + K_i/s \quad (1)$$

Where K_p is the proportional coefficient, and K_i is the integral coefficient.

G_{inv} is the equivalent gain of the inverter, and its value is equal to the ratio of DC voltage to the triangular carrier amplitude.

According to the control block diagram, the output impedance Z_o can be modeled as

$$Z_o(s) = \frac{L_1 s + L_2 s + L_1 L_2 C s^3 / (CRs + 1) + G_{inv} G_{ig}(s)}{1 + L_1 C s^2 / (CRs + 1)} \quad (2)$$

Influence of Grid Impedance on Stability

The grid-connected inverter is denoted by the Norton equivalent circuit, in which a controlled current source

is in parallel with the output impedance Z_o . The microgrid is equivalent to the series of voltage source and grid impedance. The equivalent impedance network is shown in Figure 3.

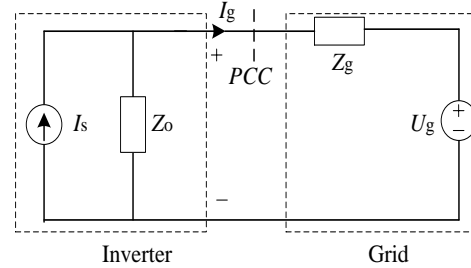

Fig.3 Equivalent circuit of grid-connected inverters

The grid current I_g can be expressed as

$$I_g(s) = [I_s(s) - \frac{U_g(s)}{Z_o(s)}] \frac{1}{1 + \frac{Z_g(s)}{Z_o(s)}} \quad (3)$$

The stability of the output current depends on the second term to the right of equation (2). $H(s)$, which is defined as $H(s) = (1 / (1 + Z_g(s) / Z_o(s)))$, is similar to a closed-loop transfer function with negative feedback, whose the positive gain is 1 and the feedback gain is $Z_g(s) / Z_o(s)$. The root locus diagram of grid-connected system with different grid impedances is shown in Figure. 4.

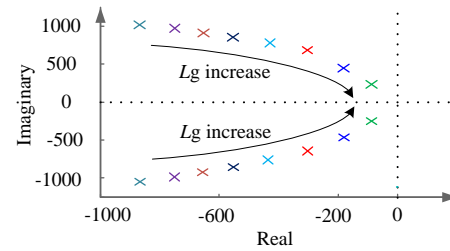

Fig.4 Root locus diagram of grid-connected system with different grid impedances

The increase of the grid impedance will cause the closed-loop pole of the grid-connected control system to gradually move to the right, and the stability of the grid will gradually decrease. The system will lose stability when there is a pole in the right half plane.

MULTIOBJECTIVE OPTIMIZATION MODEL FOR LCL FILTER PARAMETER DESIGN CONSIDERING GRID IMPEDANCE

Establishment of Optimization Model

Multiojective optimization model can be expressed as

$$\begin{cases} \min f(\mathbf{x}, \mathbf{u}) = \omega_1 f_1 + \omega_2 f_2 - \omega_3 f_3 \\ = \omega_1 (3I_h^2 R) + \omega_2 (L_1 + L_2) - \omega_3 (20 \lg |T_{f0}|) \\ s.t. \quad h_j(\mathbf{x}, \mathbf{u}) = 0 \quad j = 1, 2, \dots, p \\ g_k(\mathbf{x}, \mathbf{u}) \leq 0 \quad k = 1, 2, \dots, q \end{cases} \quad (6)$$

Where the objective function f_1 represents the minimum damping loss, and f_2 represents the minimum total inductance L_t . The objective function f_3 represents the

maximum loop gain at the fundamental frequency to ensure that the steady-state error is minimal. The weight coefficient ω_i is determined by the entropy weight method.

$\mathbf{u} = [L_1, L_2, R, C, K_p, K_i]$ represents the control variable. $\mathbf{x} = [f_c, T_{f0}, I_h]$ represents the state variable. Among them, f_c is the cutoff frequency of the equivalent open-loop system $G(s)$, which is defined as $G(s) = Z_g(s) / Z_o(s)$, and T_{f0} is the loop gain at the fundamental frequency, and I_h is the valid values of harmonic current around the switching frequency of the filter capacitor.

Constraints include stability constraints, grid harmonic current constraints and filter capacitor reactive power constraints.

(1) Equality constraints

T_{f0} can be expressed as

$$T_{f0} = \frac{K_{pwm}(K_p + K_i / j2\pi f_o)}{j2\pi f_o(L_1 + L_2)} \quad (7)$$

$Z_g(s) / Z_o(s)$ has an amplitude of 1 at the cut-off frequency f_c .

$$\left| \frac{Z_g(\mathbf{x}, \mathbf{u})}{Z_o(\mathbf{x}, \mathbf{u})} \right| - 1 = 0 \quad (8)$$

The harmonic current flowing through the filter capacitor I_h can be expressed as

$$I_h = U_h \frac{\sqrt{C^2 L_2^2 \omega_h^2 (L_1 - L_1 L_2 C \omega_h^2)^2 + (C^4 R^2 L_2^2 \omega_h^4) / L_1^2}}{(L_1 - L_1 L_2 C \omega_h^2)^2 + (RC \omega_h L_1)^2} \quad (9)$$

(2) Constraints about grid stability

In order to take into account the grid stability and dynamic response performance, the phase margin is usually 30° to 60° according to the actual engineering experience.

$$30^\circ \leq g_2(\mathbf{x}, \mathbf{u}) = 180^\circ - [90^\circ - \arg Z_o(\mathbf{x}, \mathbf{u})] \leq 60^\circ \quad (12)$$

For an inverter, which has a capacity of P_N , it needs to adapt to the maximum value of grid inductance is

$$L_{g\max} = \frac{U_{pcc}^2}{10 * P_N * 2\pi f} \quad (13)$$

(3) Constraints about harmonic current

The value of harmonic current near the switching frequency is less than 0.3% of the rated grid current.

$$g_4(\mathbf{x}, \mathbf{u}) = |i_g(j\omega_h)| = \frac{|V_{inv}(j\omega_h)| |j\omega_h RC + 1|}{\sqrt{L_1 L_2 C (j\omega_h)^3 + (L_1 + L_2) CR (j\omega_h)^2 + j\omega_h (L_1 + L_2)}} \leq 0.3\% I_N \quad (14)$$

(4) Constraints about total filter inductance

$$\frac{U_{dc}}{4\sqrt{3}\Delta I_{ripple_max} f_{sw}} \leq g_3(\mathbf{x}, \mathbf{u}) = L_t \leq \frac{\sqrt{U_{dc}^2 / 3 - E_{mp}^2}}{w I_{mp}} \quad (15)$$

Where ΔI_{ripple_max} is maximum allowed value phase current ripple. I_{mp} and E_{mp} is peak phase current and peak phase voltage, respectively

(5) Constraints about reactive power of capacitor

The reactive power of filter capacitor does not exceed

5% of rated power.

$$g_6(\mathbf{x}, \mathbf{u}) = 3 * 2\pi f_1 U_N^2 C \leq 5\% P_N \quad (16)$$

Solution of Optimization Model

The particle swarm optimization with compressibility factor is helpful to enhance the convergence of PSO algorithm, and high-quality solutions can be searched in different areas. Each particle update their speed and location according to (17) and (18).

$$v_{id}^{k+1} = \chi (w v_{id}^k + c_1 rand_1^k (pbest_{id}^k - x_{id}^k) + c_2 rand_2^k (gbest_d^k - x_{id}^k)) \quad (17)$$

$$x_{id}^{k+1} = x_{id}^k + v_{id}^{k+1} \quad (18)$$

Where v_{id}^k and x_{id}^k is the velocity and the position of particle d in the k th iteration, respectively. c_1 and c_2 are acceleration factors. $rand_1$ and $rand_2$ are random numbers between $[0, 1]$. χ is a compression factor, which can be selected according to (19)

$$\chi = 2 / \left| 2 - \varphi - (\varphi^2 - 4\varphi)^{1/2} \right| \quad (19)$$

Where $\varphi = c_1 + c_2$, and $\varphi > 4$.

DESIGN EXAMPLE AND COMPARATIVE ANALYSIS

Design example

We optimize the parameters of the following grid-connected inverter in Table I.

Tab I Grid-connected system parameters of inverter

Parameters	value	Parameters	value
f_g/Hz	50	f_{sw}/kHz	3
u_g/V	220	U_{dc}/V	650
P_N/kW	10	I_{mp}/A	21
f_s/kHz	6	λc_{L1}	30%

In order to demonstrate the superiority of the proposed method in this paper, we give the design results with optimized design for minimal damping power loss (method I) and proposed method (method II), which are shown in Tab II

Tab II Optimized results of two design schemes

parameter	method I	method II
L_1	13.1mH	12mH
L_2	3.9mH	4.2mH
C	10uF	6uF
R	5Ω	8.5Ω

The fuzzy membership function is defined to compare the optimization results quantitatively.

$$\mu_i = \begin{cases} 1 & f_i < f_{i\min} \\ \frac{f_{i\max} - f_i}{f_{i\max} - f_{i\min}} & f_{i\min} \leq f_i \leq f_{i\max} \\ 0 & f_i > f_{i\max} \end{cases} \quad (20)$$

The closer u_i is to 1, the more satisfied the index u_i is. Finally, the degree of the optimization result is judged by standardizing the satisfaction value μ . According to (20), $\mu=0.63$ for the method I, and $\mu=0.82$ for the method II, which shows the proposed optimization can balance well cost and filtering performance and stability margin.

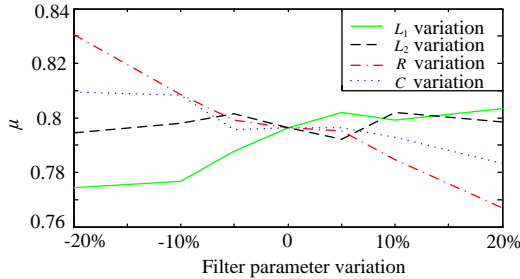

Fig.5 Index sign of grid-connected system with different LCL filter parameters

Fig 5 shows the index sign of system with different LCL filter parameters. The damping resistance has the greatest effect on the final standardized satisfaction value. So the precise selection of damp resistance is indispensable for achieving the desired performances.

Simulation Results

To validate the presented analysis, a 10kW grid-connected inverter is established in matlab/simulink.

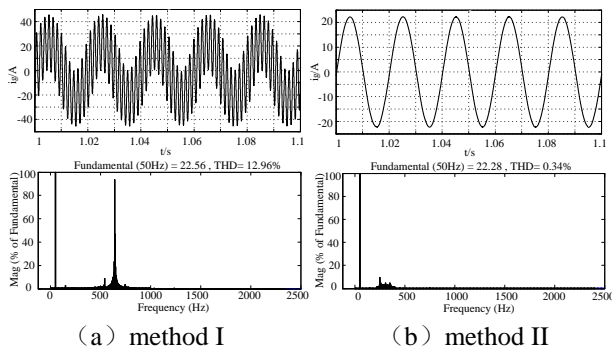

Fig. 6 Inverter output current with SCR=10

Fig.6 shows the simulated waveform of output current when the inverter operates under the microgrid with SCR=10. As we can see, the grid current of inverter designed by method I has a serious distortion and the harmonic oscillations cause the system to work abnormally.

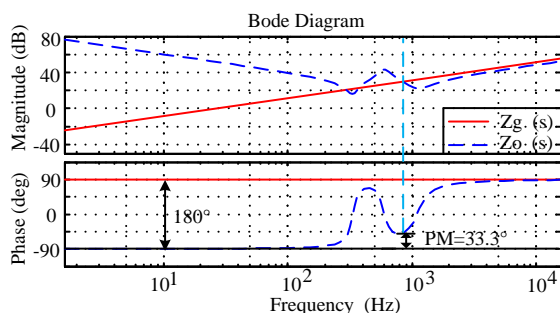

Fig.7 Inverter output impedance and grid impedance of the second scheme with SCR=10

For the inverter designed by the proposed method in this paper, because the grid system has enough stability margin, which is showed in Fig. 7, the system work stably and has a high quality output current. These simulations validate the effectiveness of the proposed method.

CONCLUSION

This paper has presented a LCL-filter optimization design considering stability of grid-connected inverters in microgrid, and the particle swarm optimization with compressibility factor is used to find the optimal solution. According to the comparative analysis and simulation results, the proposed design method has a overall optimization to inverter parameters, which can balance well cost and filter performance and increase stability margin, especially suited for LCL filter parameters design under microgrid.

REFERENCES

- [1] Blaabjerg F, Teodorescu R, et al, 2006, " Overview of control and grid synchronization for distributed power generation systems ", *IEEE Trans on Industrial Electronics*. 53. 5, 1398-1409.
- [2] J He, Y Li, 2012, " Generalized closed-loop control schemes with embedded virtual impedances for voltage source converters with LC or LCL filters ", *IEEE Trans on Power Electronics*. 27. 4, 1850-1861.
- [3] Reznik A, Simoes M G and Durra A A, 2014, " LCL filter design and performance analysis for grid inter-connected systems ", *IEEE Trans on Industrial Applications*. 50. 2, 1225-1232.
- [4] Y Wang, F Wu and L Sun, 2010, " Optimized design of LCL filter for minimal damping power loss ", *Proceedings of the CSEE*. 30. 27, 90-95.
- [5] Muhlethaler J and Schweizer M, 2013, " Optimal design of LCL harmonic filters for three-phase PFC rectifiers ", *IEEE Trans on Power Electronics*. 57. 12, 4106-4114.
- [6] D Xu, F Wang and H Mao, 2013, "Modeling and analysis of harmonic interaction between multiple grid-connected inverters and the utility grid", *Proceedings of the CSEE*. 33. 12, 64-71.
- [7] W Wu, Y Li and Y He, 2017, " Damping method for resonance caused by LCL-filter-based current-controlled grid-tied power inverters", *IEEE Trans on Industrial Electronics*. pp. 99, 1-1.
- [8] X Zheng, L Xiao and Y Lei, 2015, " Optimisation of LCL filter based on closed-loop total harmonic distortion calculation model of the grid-connected inverter ", *Power Electronics Let*. 8. 6, 860-868.
- [9] J Xu, L Ji and X Ge, 2016, " LCL-filter optimization design with consideration of inverte side current feedback control impacts ", *Proceedings of the CSEE*. 36. 17, 4656-4663.